

## A – Series

### Enclosures NEMA 1 Hinge Cover Wall-Mount

#### Industry Standards

UL 50, Type 1  
CSA Certified, Type 1  
NEMA/EEMAC Type 1

#### Construction

- Bodies and doors fabricated from 16 gauge steel
- Boxes have a pull handle and a friction catch to secure cover
- 3" depth boxes furnished with formed steel hinge non removable cover.  
4" and 6" depth boxes furnished with clamp style hinges allowing for removable/replaceable covers
- Various sizes of removable concentric knockouts are furnished on all four sides of standard cutout boxes
- Mounting holes on back of box



#### Applications

Designed for use as surface-mounted junction box, service box, switch box and cutout box.

#### Finish

- ANSI-61 gray polyester powder inside and out over phosphatized surfaces

#### Accessories

- See accessories section.

A SERIES HINGE COVER ENCLOSURES				
CATALOG NUMBER	BODY/DOOR STEEL GAUGE	ENCLOSURE SIZE H X W X D	KNOCKOUT PATTERNS	
			WIDTH SIDE	HEIGHT SIDE
A040503	16/16	5.00x4.50x3.00 (127x114x76)	A-A	A-A
A060603	16/16	6.00x6.00x3.00 (152x152x76)	A-B-A	A-B-A
A040604	16/16	6.00x4.00x4.00 (152x102x102)	A-A	A-B-A
A060604	16/16	6.00x6.00x4.00 (152x152x102)	A-B-A	A-B-A
A060804	16/16	8.00x6.00x4.00 (203x152x102)	A-B-A	A-B-A
A080804	16/16	8.00x8.00x4.00 (203x203x102)	A-B-A	A-B-A
A081004	16/16	10.00x8.00x4.00 (254x203x102)	A-B-A	B-A-F-F-A
A081204	16/16	12.00x8.00x4.00 (305x203x102)	A-B-A	B-A-F-F-A-B
A101004	16/16	10.00x10.00x4.00 (254x254x102)	B-A-F-F-A	B-A-F-F-A
A101204	16/16	12.00x10.00x4.00 (305x254x102)	B-A-F-F-A	B-A-F-F-A-B
A121204	16/16	12.00x12.00x4.00 (305x305x102)	B-A-F-F-A-B	B-A-F-F-A-B
A121504	16/16	15.00x12.00x4.00 (381x305x102)	B-A-F-F-A-B	A-B-A-F-F-A-B-A
A121604	16/16	16.00x12.00x4.00 (406x305x102)	B-A-F-F-A-B	A-B-A-F-F-A-B-A
A121804	16/16	18.00x12.00x4.00 (457x305x102)	B-A-F-F-A-B	A-B-A-F-F-A-B-A
A151804	16/16	18.00x15.00x4.00 (457x381x102)	A-B-A-F-F-A-B-A	A-B-A-F-F-A-B-A
A060606	16/16	6.00x6.00x6.00 (152x152x152)	A-B-A	A-B-A
A080806	16/16	8.00x8.00x6.00 (203x203x152)	A-B-A	A-B-A
A081006	16/16	10.00x8.00x6.00 (254x203x152)	A-B-A	B-A-F-F-A
A101006	16/16	10.00x10.00x6.00 (254x254x152)	B-A-F-F-A	B-A-F-F-A
A101206	16/16	12.00x10.00x6.00 (305x254x152)	B-A-F-F-A	B-A-F-F-A-B
A121206	16/16	12.00x12.00x6.00 (305x305x152)	B-A-F-F-A-B	B-A-F-F-A-B
A121606	16/16	16.00x12.00x6.00 (406x305x152)	B-A-F-F-A-B	A-B-A-F-F-A-B-A
A121806	16/16	18.00x12.00x6.00 (457x305x152)	B-A-F-F-A-B	A-B-A-F-F-A-B-A
A151506	16/16	15.00x15.00x6.00 (381x381x152)	A-B-A-F-F-A-B-A	A-B-A-F-F-A-B-A
A161606	16/16	16.00x16.00x6.00 (406x406x152)	A-B-A-F-F-A-B-A	A-B-A-F-F-A-B-A
A181806	16/16	18.00x18.00x6.00 (457x457x152)	A-B-A-F-F-A-B-A	A-B-A-F-F-A-B-A
A182406	14/14	24.00x18.00x6.00 (610x457x152)	A-B-A-F-F-A-B-A	A-B-A-F-F-A-B-A
A242406	14/14	24.00x24.00x6.00 (610x610x152)	A-B-A-F-F-A-B-A	A-B-A-F-F-A-B-A
A243006	14/14	30.00x24.00x6.00 (762x610x152)	A-B-A-F-F-A-B-A	A-B-A-F-F-A-B-A
A243606	14/14	36.00x24.00x6.00 (914x610x152)	A-B-A-F-F-A-B-A	A-B-A-F-F-A-B-A
A243608	14/14	36.00x24.00x8.00 (914x610x203)	A-B-A-F-F-A-B-A	A-B-A-F-F-A-B-A

NOTE: Must specify CSA Label when ordering.

## Knockout Patterns

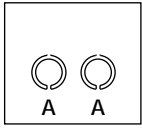

4-1/2" & 5" SIDE

A - 1/2" TO 3/4"  
 B - 3/4" TO 1"  
 F - 1" TO 1-1/4"

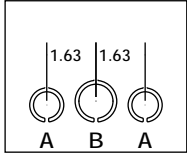

6" & 8" SIDE

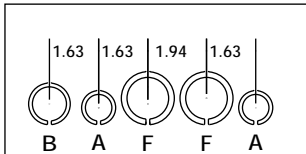

10" SIDE

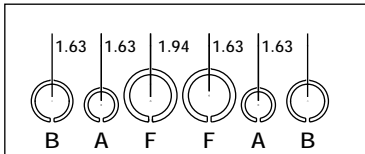

12" SIDE

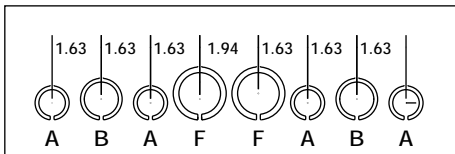

15", 16", 18", 24"  
 30" & 36" SIDE.

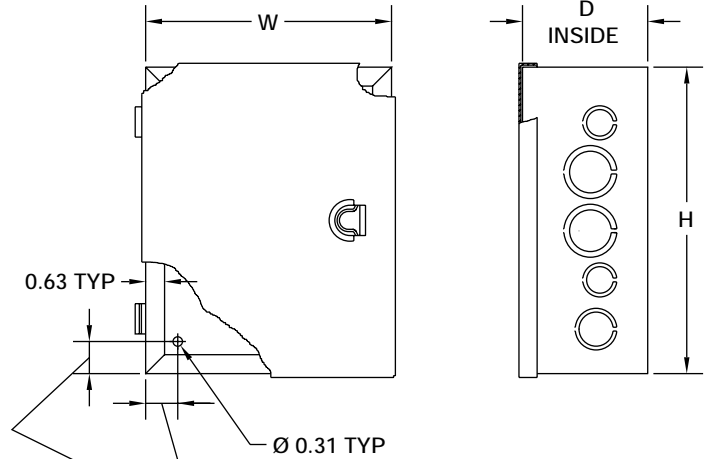
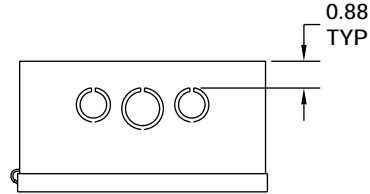

1.06 FOR W & H = 9.12" OR LESS  
 1.56 FOR W OR H > 9.12"

To learn more about B-I-A please visit us at our  
 WEB site: [www.BiaGmbH.com](http://www.BiaGmbH.com)

