

TWO-GANG DEVICE COVERS



Application

- For use whenever weatherproof protection is required for an outdoor receptacle

Product Features

- Rugged metallic construction
- State-of-the-art powder coat finish provides maximum weatherability and scratch resistance
- Self-closing lids assure weatherproof protection when the receptacle is not in use
- Includes installation hardware, gasket, and multi-lingual instructions

Compliances

-  – Standard 514A
-  – C22.2
- NEMA 3R Rated

5157-0 SERIES, 5092-0

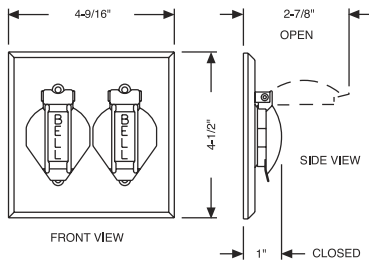

TWO-GANG DEVICE COVERS

5148-0 SERIES, 5096-0 5160-0, 5098-0

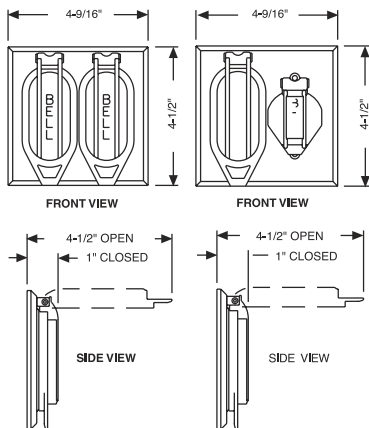

NOTE: DIMENSIONS ARE THE SAME FOR DEVICE MOUNT AND BOX MOUNT STYLES SHOWN.
5157-0 SERIES, 5092-0

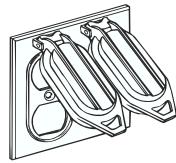

5148-0 TO 5148-5

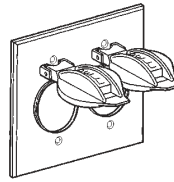

5157-0

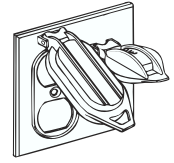

5160-0

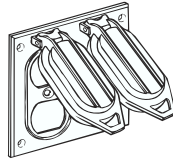

5096-0

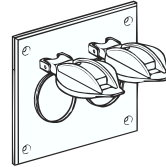

5092-0

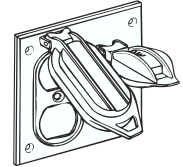

5098-0

ORDERING INFORMATION - DIMENSIONS

DEVICE MOUNT					
CATALOG NUMBER	COLOR	RECEPTACLE TYPE	PKG. TYPE	STD. PKG.	UPC BAR CODE
5148-0	Gray	(2) Duplex	Shrink	18	
5148-1	White	(2) Duplex	Shrink	18	
5148-2	Bronze	(2) Duplex	Shrink	18	
5148-5	Gray	(2) Duplex	Carded	4	
5157-0	Gray	(2) Single, 1.406" dia.	Shrink	18	
5160-0	Gray	(1) Duplex & (1) Single, 1.406" dia.	Shrink	12	

BOX MOUNT					
CATALOG NUMBER	COLOR	RECEPTACLE TYPE	PKG. TYPE	STD. PKG.	UPC BAR CODE
5096-0	Gray	(2) Duplex	Shrink	12	
5092-0	Gray	(2) Single, 1.406" dia.	Shrink	12	
5098-0	Gray	(1) Duplex & (1) Single, 1.406" dia.	Shrink	12	