

## TWO- AND THREE-GANG DEVICE COVERS



### Applications

- For use whenever weatherproof protection is required for an outdoor receptacle
- Blank covers for use whenever weatherproof protection is required for a multi-gang box

### Product Features

- Rugged metallic construction
- State-of-the-art powder coat finish provides maximum weatherability and scratch resistance
- Self-closing lids assure weatherproof protection when the receptacle is not in use
- Includes installation hardware, gasket, and multi-lingual instructions

### Compliances

-  – Standard 514A (5097-0, 5175 Series, 5093-0 and 5177-0)
-  – C22.2 #18 (5097-0, 5175 Series and 5093-0)
-  – 5177-0 (only)
- NEMA 3R Rated

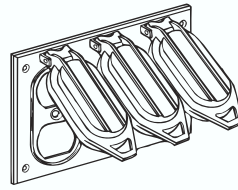

5097-0

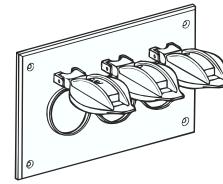

5093-0

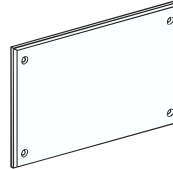

5177-0

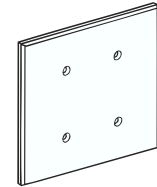

5175-0 TO 5175-5

## ORDERING INFORMATION - DIMENSIONS

THREE-GANG DEVICE COVER - BOX MOUNT					
CATALOG NUMBER	COLOR	DESCRIPTION	PKG. TYPE	STD. PKG.	UPC BAR CODE
5097-0	Gray	(3) Duplex	Boxed	1	
5093-0	Gray	(3) Single, 1.406" dia.	Boxed	1	

THREE-GANG BLANK COVER - BOX MOUNT					
CATALOG NUMBER	COLOR	DESCRIPTION	PKG. TYPE	STD. PKG.	UPC BAR CODE
5177-0	Gray	Blank Cover	Boxed	10	

TWO-GANG BLANK COVER - BOX MOUNT					
CATALOG NUMBER	COLOR	DESCRIPTION	PKG. TYPE	STD. PKG.	UPC BAR CODE
5175-0	Gray	Blank Cover	Shrink	25	
5175-1	White	Blank Cover	Shrink	25	
5175-2	Bronze	Blank Cover	Shrink	25	
5175-5	Gray	Blank Cover	Carded	6	

### THREE-GANG DEVICE COVERS

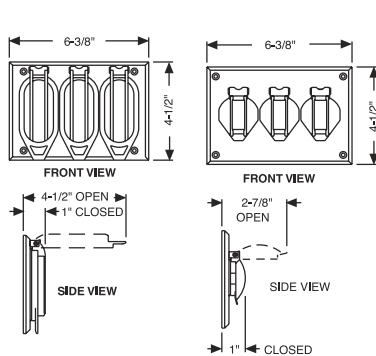

### BLANK COVERS

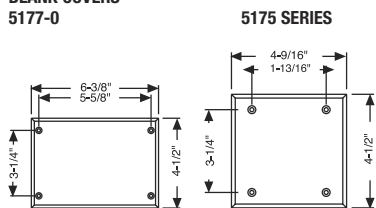

NOTE: DIMENSIONS ARE THE SAME FOR DEVICE MOUNT AND BOX MOUNT STYLES SHOWN.