

LAMPHOLDERS DIE CAST ZINC



Applications

- For outdoor or indoor lighting use
- May be used with cluster covers and boxes

Product Features

- Rugged metallic construction
- State-of-the-art powder coat finish provides maximum weatherability and scratch-resistance
- Locking swivel knuckle assures positive lamp positioning and provides pin-point directional aiming
- Extra long wire leads for easy hook-up
- Each lampholder supplied with a porcelain socket, inside gasket, 1/2" locknut and multi-lingual instructions

Compliances

-  – Standard 496, 1570 & 1571
- 

5613 SERIES

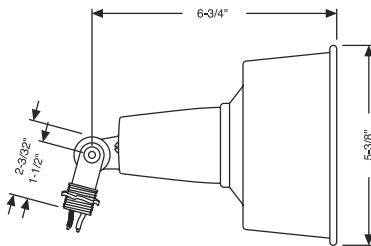

LAMPHOLDERS 5606 SERIES, 5612-0

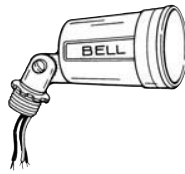
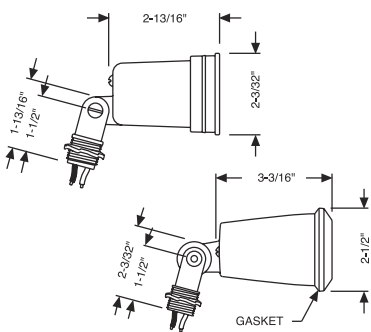

5606-0

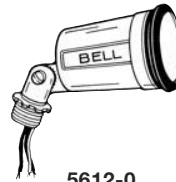

5612-0



5611-0

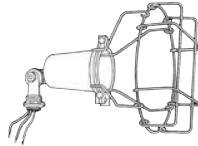

5615-0

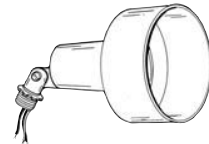

5613-0 TO 5613-2

ORDERING INFORMATION - DIMENSIONS

LAMPHOLDERS AND ACCESSORIES FOR 75-150 WATT PAR 38 LAMPS

CATALOG NUMBER	COLOR	DESCRIPTION	PKG. TYPE	STD. PKG.	UPC BAR CODE
5606-0	Gray	Lampholder	Shrink	30	
5606-1	White	Lampholder	Shrink	30	
5606-2	Bronze	Lampholder	Shrink	30	
5606-5	Gray	Lampholder	Carded	6	
5606-6	White	Lampholder	Carded	6	
5606-7	Bronze	Lampholder	Carded	6	
5612-0	Gray	Lampholder w/gasket	Shrink	30	
5611-0	—	Outer gasket only, replacement gasket for 5612-0	Polybag	30	
5615-0	—	Wire guard only	Shrink	5	

ARCHITECTURAL LAMPHOLDERS FOR 75-150 WATT PAR 38 LAMPS

CATALOG NUMBER	COLOR	DESCRIPTION	PKG. TYPE	STD. PKG.	UPC BAR CODE
5613-0	Gray	Lampholder	Shrink	4	
5613-1	White	Lampholder	Shrink	4	
5613-2	Bronze	Lampholder	Shrink	4	

CATALOG NO. 5611-0

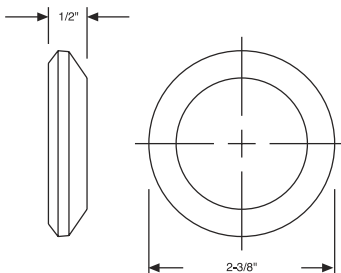

CATALOG NO. 5615-0

