



HW-J121005CHQR

JIC Series – Non-Metallic Enclosures Opaque, Hinged Cover with Quick Release Latches

Construction

- Hot compression molded fiberglass reinforced thermoset polyester
- Poured polyurethane seamless gasket provides watertight, dust-tight environmental seal
- Recessed pan head screws – no protruding surfaces
- 300 Series stainless steel used on all external hardware
- Rounded edges, minimal protrusions or exposed pocket areas for accumulation of dust or debris
- Molded in flange for easy mounting
- Panel mounting capability for fixed rear panel
- Raised bosses with brass inserts accepting 10-32 screws for optional panel mounting
- Workable material cuts, drills, punches and saws with ease and accuracy
- Submersible, non-corrosive environmental design
- Full length stainless steel hinged cover

- Integral hasp provides secure loop for padlock (padlock not included)
- Non-conductive, impact resistant, UV resistant
- Smooth surface, no color variations, swirls or color pockets, no voids
- Color: Gray

Listings

- UL/cUL 50/508, Types 1, 3, 4X, 6P, 12
- UL File E64791
- CSA Standard C22.2 File 222873 Types 1, 3, 4x, 6P, 12
- NEMA Standard 250 Types 1, 3, 4x, 6P, 12
- Temperature Range: -40°F to 250°F (-40°C to 120°C)
- Flammability Rating: UL94-5V
- Non-flame propagating



JIC Series with Opaque Hinged Cover and Quick Release Latches

Part Number	Enclosure Overall Size HxWxD	Enclosure Inside AxBxC	Wt.	Carbon Steel Subpanel	Fiberglass Subpanel	Stainless Steel Subpanel	Aluminum Subpanel
HW-J60404CHQR	7.50 x 5.43 x 4.75 (191 x 138 x 121)	5.84 x 3.85 x 4.45 (148 x 98 x 113)	2.5 lbs.	HW-MP604CS	HW-MP604FG	HW-MP604SS	HW-MP604A
HW-J60604CHQR	7.50 x 7.50 x 4.75 (191 x 191 x 121)	5.72 x 5.72 x 4.45 (145 x 145 x 113)	2.75 lbs.	HW-MP606CS	HW-MP606FG	HW-MP606SS	HW-MP606A
HW-J80604CHQR	9.62 x 7.50 x 4.74 (244 x 191 x 121)	7.73 x 5.74 x 4.45 (196 x 146 x 113)	3.5 lbs.	HW-MP806CS	HW-MP806FG	HW-MP806SS	HW-MP806A
HW-J100804CHQR	11.62 x 9.41 x 4.25 (295 x 239 x 108)	9.73 x 7.73 x 3.98 (247 x 196 x 101)	5 lbs.	HW-MP1008CS	HW-MP1008FG	HW-MP1008SS	HW-MP1008A
HW-J100805CHQR (crowned cover)*	11.62 x 9.37 x 5.06 (295 x 238 x 129)	9.73 x 7.73 x 4.83 (247 x 196 x 123)	5 lbs.	HW-MP1008CS	HW-MP1008FG	HW-MP1008SS	HW-MP1008A
HW-J121005CHQR	13.56 x 11.43 x 5.21 (344 x 291 x 132)	11.79 x 9.80 x 4.94 (299 x 249 x 125)	6.5 lbs.	HW-MP1210CS	HW-MP1210FG	HW-MP1210SS	HW-MP1210A
HW-J141206CHQR	15.50 x 13.50 x 6.25 (394 x 343 x 159)	13.53 x 11.55 x 5.94 (344 x 293 x 151)	8.5 lbs.	HW-MP1412CS	HW-MP1412FG	HW-MP1412SS	HW-MP1412A
HW-J161406CHQR	17.53 x 15.46 x 6.23 (445 x 393 x 158)	15.63 x 13.60 x 5.94 (397 x 345 x 151)	11.5 lbs.	HW-MP1614CS	HW-MP1614FG	HW-MP1614SS	HW-MP1614A
HW-J181608CHQR	19.62 x 17.61 x 8.82 (498 x 447 x 224)	17.69 x 15.69 x 8.45 (449 x 399 x 215)	19.25 lbs.	HW-MP1816CS	HW-MP1816FG	HW-MP1816SS	HW-MP1816A
HW-J201608CHQR	22.00 x 17.68 x 8.83 (559 x 449 x 224)	19.72 x 15.72 x 8.45 (501 x 399 x 215)	20.25 lbs.	HW-MP2016CS	HW-MP2016FG	HW-MP2016SS	HW-MP2016A

Note: Subpanels must be ordered separately. Dimensions in inches (millimeters).

*Note: In crowned cover units, the center of the cover is raised 3/4". Crowned cover is available only in 10x8x5 size enclosure.

DATA SUBJECT TO CHANGE WITHOUT NOTICE



HW-J100 0 CHQRW

JIC Series – Non-Metallic Enclosures
Opaque, Hinged Cover with Quick Release Latches and Window

Construction

- Hot compression molded fiberglass reinforced thermoset polyester
- Poured polyurethane seamless gasket provides watertight, dust-tight environmental seal
- Full length stainless steel hinge
- 300 Series stainless steel used on all external hardware
- Rounded edges, minimal protrusions or exposed pocket area for accumulation of dust or debris
- Molded-in flange for easy mounting
- Panel mounting capability for fixed rear panel
- Raised bosses with brass inserts accepting 10-32 screws for optional panel mounting
- Workable material cuts, drills, punches and saws with ease and accuracy
- Padlock latch (padlock not included)
- Snap catch concept with toggle action
- Scratch and abrasion resistant UVA acrylic flush bonded window
- Submersible, non-corrosive environmental design

- Full 180° door opening
- Non-conductive, impact resistant, UV resistant
- Smooth surface, no color variations, swirls or color pockets, no voids
- Color: Gray

Listings

- UL/cUL 50/508, Types 1, 3, 4X, 6P, 12
- UL File E64791
- CSA Standard C22.2 File 222873 Types 1, 3, 4x, 6P, 12
- NEMA Standard 250 Types 1, 3, 4x, 6P, 12
- Temperature Range: -40°F to 250°F (-40°C to 120°C)
- Flammability Rating: UL94-5V
- Window flammability: UL94V-0
- Non-flame propagating



JIC Series with Quick Release Latches and Window								
Part Number	Enclosure Overall Size HxWxD	Enclosure Inside AxBxC	Window Area (Maximum)	Wt.	Carbon Steel Subpanels	Fiberglass Subpanels	Stainless Steel Subpanels	Aluminum Subpanels
HW-J60404CHQRW	7.50 x 5.43 x 4.75 (191 x 138 x 121)	5.84 x 3.85 x 4.45 (148 x 98 x 113)	4.25 x 2.25 (108 x 57)	2.5 lbs	HW-MP604CS	HW-MP604FG	HW-MP604SS	HW-MP604A
HW-J60604CHQRW	7.50 x 7.50 x 4.75 (191 x 191 x 121)	5.72 x 5.72 x 4.45 (145 x 145 x 113)	4.25 x 4.25 (108 x 108)	2.75 lbs	HW-MP606CS	HW-MP606FG	HW-MP606SS	HW-MP606A
HW-J80604CHQRW	9.62 x 7.50 x 4.74 (244 x 191 x 121)	7.73 x 5.74 x 4.45 (196 x 146 x 113)	6.25 x 4.25 (159 x 108)	3.5 lbs	HW-MP806CS	HW-MP806FG	HW-MP806SS	HW-MP806A
HW-J100804CHQRW	11.62 x 9.41 x 4.25 (295 x 239 x 108)	9.73 x 7.73 x 3.98 (247 x 196 x 101)	8.25 x 6.25 (210 x 159)	5 lbs	HW-MP1008CS	HW-MP1008FG	HW-MP1008SS	HW-MP1008A
HW-J121005CHQRW	13.56 x 11.43 x 5.21 (344 x 291 x 132)	11.79 x 9.80 x 4.94 (299 x 249 x 125)	10.25 x 8.25 (260 x 210)	6.5 lbs	HW-MP1210CS	HW-MP1210FG	HW-MP1210SS	HW-MP1210A
HW-J141206CHQRW	15.50 x 13.50 x 6.25 (394 x 343 x 159)	13.53 x 11.55 x 5.94 (344 x 293 x 151)	12.25 x 10.25 (311 x 260)	8.5 lbs	HW-MP1412CS	HW-MP1412FG	HW-MP1412SS	HW-MP1412A
HW-J161406CHQRW	17.53 x 15.46 x 6.23 (445 x 393 x 158)	15.63 x 13.60 x 5.94 (397 x 345 x 151)	14.25 x 12.25 (362 x 311)	11.5 lbs	HW-MP1614CS	HW-MP1614FG	HW-MP1614SS	HW-MP1614A
*HW-J181608CHQRW	19.62 x 17.61 x 8.82 (498 x 447 x 224)	17.69 x 15.69 x 8.45 (449 x 399 x 215)	16.25 x 14.25 (413 x 362)	19.25 lbs	HW-MP1816CS	HW-MP1816FG	HW-MP1816SS	HW-MP1816A
*HW-J201608CHQRW	22.00 x 17.68 x 8.83 (559 x 449 x 224)	19.72 x 15.72 x 8.45 (501 x 399 x 215)	18.25 x 14.25 (463 x 413)	20.25 lbs.	HW-MP2016CS	HW-MP2016FG	HW-MP2016SS	HW-MP2016A

Note: Subpanels must be ordered separately. Dimensions in inches (millimeters).

***Note: 1816 and 2016 sizes are not 6P Rated.**

DATA SUBJECT TO CHANGE WITHOUT NOTICE

JIC Series – Non-Metallic Enclosures
Opaque, Hinged Cover with Quick Release Latches and Window

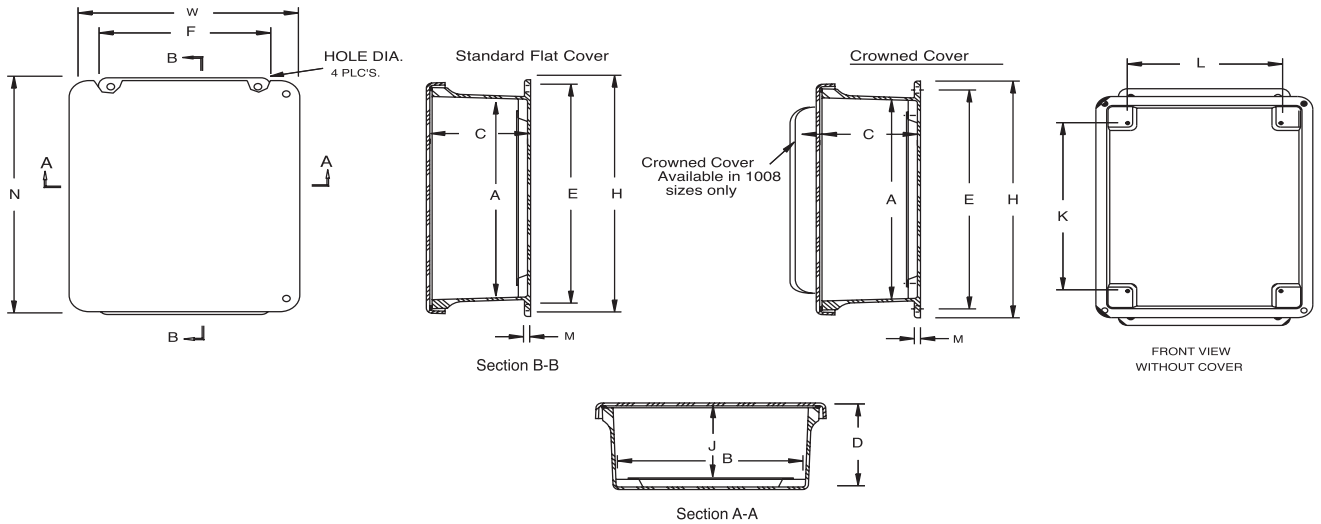

Dimensions for JIC Series Non-Metal Enclosures									
JIC Base* Part Number	Enclosure Overall Size HxWxD	Enclosure Inside Dimensions AxBxC	Mounting ExF	J	K	L	M	N	Hole Dia.
HW-J60404*	7.50 x 5.43 x 4.75 (191 x 138 x 121)	5.84 x 3.85 x 4.45 (148 x 98 x 113)	6.75 x 2 (171 x 51)	4 (101)	4.25 (108)	2.25 (57)	0.25 (6)	7.39 (188)	0.31 (8)
HW-J60604*	7.50 x 7.50 x 4.75 (191 x 191 x 121)	5.72 x 5.72 x 4.45 (145 x 145 x 113)	6.75 x 4 (171 x 101)	4 (101)	4.25 (108)	4.25 (108)	0.25 (6)	7.52 (191)	0.31 (8)
HW-J80604*	9.62 x 7.50 x 4.74 (244 x 191 x 121)	7.73 x 5.74 x 4.45 (196 x 146 x 113)	8.88 x 4 (225 x 101)	4 (101)	6.25 (159)	4.25 (108)	0.25 (6)	9.5 (242)	0.31 (8)
HW-J100804*	11.62 x 9.41 x 4.25 (295 x 239 x 108)	9.73 x 7.73 x 3.98 (247 x 196 x 101)	10.75 x 6 (273 x 152)	3.5 (89)	8.25 (209)	6.25 (159)	0.25 (6)	11.35 (288)	0.31 (8)
HW-J100805* (crowned cover)	11.62 x 9.37 x 5.06 (295 x 238 x 129)	9.73 x 7.73 x 4.83 (247 x 196 x 123)	10.75 x 6 (273 x 152)	4.37 (111)	8.25 (209)	6.25 (159)	0.25 (6)	11.37 (289)	0.31 (8)
HW-J121005*	13.56 x 11.43 x 5.21 (344 x 291 x 132)	11.79 x 9.80 x 4.94 (299 x 249 x 125)	12.75 x 8 (324 x 203)	4.5 (114)	10.25 (260)	8.25 (209)	0.25 (6)	13.41 (341)	0.31 (8)
HW-J141206*	15.50 x 13.50 x 6.25 (394 x 343 x 159)	13.53 x 11.55 x 5.94 (344 x 293 x 151)	14.62 x 10 (371 x 254)	5.37 (137)	12.25 (311)	10.25 (260)	0.25 (6)	15.47 (393)	0.31 (8)
HW-J161406*	17.53 x 15.46 x 6.23 (445 x 393 x 158)	15.63 x 13.60 x 5.94 (397 x 345 x 151)	16.75 x 12 (425 x 305)	5.36 (136)	14.25 (362)	12.25 (311)	0.25 (6)	17.45 (443)	0.31 (8)
HW- J181608*	19.62 x 17.61 x 8.82 (498 x 447 x 224)	17.69 x 15.69 x 8.45 (449 x 399 x 215)	18.88 x 12 (479 x 305)	7.99 (203)	16.25 (413)	14.25 (362)	0.25 (6)	19.61 (498)	0.31 (8)
HW-J201608*	22.00 x 17.68 x 8.83 (559 x 449 x 224)	19.72 x 15.7 x 8.45 (501 x 399 x 215)	21.25 x 10.00 (540 x 254)	8 (203)	18.25 (464)	14.25 (362)	0.25 (6)	21.68 (551)	0.31 (8)

Note: Dimensions in inches (millimeters); letters in table correspond to letters on dimensional drawings.
 Note: Base Part Number denotes enclosure size only. Defining alphabetical characters are represented by an asterisk (for example: HW-J60604* denotes dimensions for HW-J60604SC, HW-J60604CHSC, HW-J60604CHQR, HW-JCC60604CHQRW, or HW-J60604CHTLW. Do not use Base Part Numbers to order enclosures. Use only complete part numbers when ordering.

DATA SUBJECT TO CHANGE WITHOUT NOTICE

Subpanels – Non-Metallic Enclosures
Subpanels for All Premier and JIC Non-metallic Enclosures

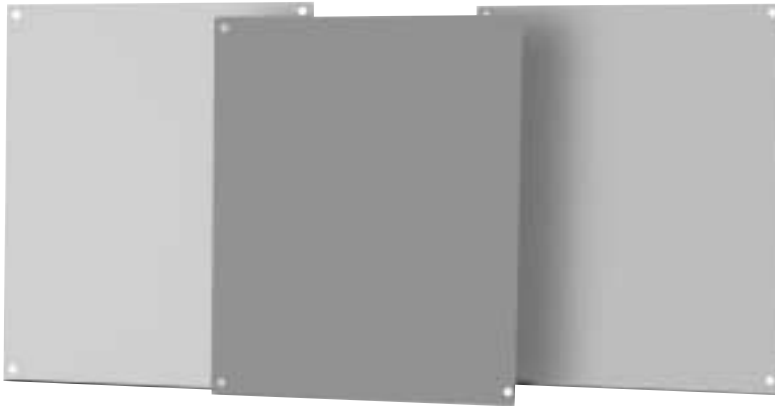

Subpanel Specifications		
Subpanel	Material	Finish
Carbon Steel	Carbon Steel	White polyester powder Finish
Aluminum	3003H14 Aluminum	Mill Finish
Stainless Steel	304 Stainless	304 ANN 2 B Finish
Fiberglass	FRP (Fiberglass reinforced panel)	Gray Finish

Carbon Steel Subpanels for All Premier and JIC Non-metallic Enclosures

Subpanel Part Number	Subpanel Size HxW	Enclosure Size HxW	BA	BB	BK	BL	BT	Panel Type	Number of Holes	Hole Diameter	Wt.
HW-MP604CS	4.88 x 2.88 (124 x 73)	6 x 4 (152 x 102)	4.88 (124)	2.88 (73)	4.25 (108)	2.25 (57)	0.08 (2)	FLAT	4	.25 (6.35)	5 oz.
HW-MP606CS	4.88 x 4.88 (124 x 124)	6 x 6 (152 x 152)	4.88 (124)	4.88 (124)	4.25 (108)	4.25 (108)	0.08 (2)	FLAT	4	.25 (6.35)	8 oz.
HW-MP706CS	6.00 x 4.88 (152 x 124)	7 x 6 (179 x 152)	6.00 (152)	4.88 (124)	5.38 (137)	4.25 (108)	0.08 (2)	FLAT	4	.25 (6.35)	10 oz.
HW-MP806CS	6.75 x 4.88 (152 x 124)	8 x 6 (203 x 152)	6.75 (152)	4.88 (124)	6.25 (159)	4.25 (108)	0.08 (2)	FLAT	4	.25 (6.35)	12 oz.
HW-MP808CS	6.88 x 6.88 (175 x 175)	8 x 8 (203 x 203)	6.88 (175)	6.88 (175)	6.25 (159)	6.25 (159)	0.08 (2)	FLAT	4	.25 (6.35)	12 oz.
HW-MP906CS	8.25 x 4.88 (175 x 124)	9 x 6 (229 x 152)	8.25 (210)	4.88 (124)	7.63 (194)	4.25 (108)	0.08 (2)	FLAT	4	.25 (6.35)	14 oz.
HW-MP1008CS	8.75 x 6.88 (225 x 175)	10 x 8 (254 x 203)	8.75 (225)	6.88 (175)	8.25 (210)	6.25 (159)	0.08 (2)	FLAT	4	.25 (6.35)	21 oz.
HW-MP1210CS	10.88 x 8.75 (276 x 225)	12 x 10 (305 x 254)	10.88 (276)	8.75 (225)	10.25 (260)	8.25 (210)	0.08 (2)	FLAT	4	.25 (6.35)	34 oz.
HW-MP1412CS	12.88 x 10.88 (327 x 276)	14 x 12 (356 x 305)	12.88 (327)	10.88 (276)	12.25 (311)	10.25 (260)	0.08 (2)	FLAT	4	.25 (6.35)	48 oz.
HW-MP1614CS	14.88 x 12.88 (378 x 327)	16 x 14 (406 x 356)	14.88 (378)	12.88 (327)	14.25 (362)	12.25 (311)	0.08 (2)	FLAT	4	.25 (6.35)	66 oz.
HW-MP1816CS	16.88 x 14.88 (429 x 378)	18 x 16 (457 x 406)	16.88 (429)	14.88 (378)	16.25 (413)	14.25 (362)	0.08 (2)	FLAT	4	.25 (6.35)	87 oz.
HW-MP2016CS	18.88 x 14.88 (479 x 378)	20 x 16 (508 x 406)	18.88 (479)	14.88 (378)	18.25 (464)	14.25 (362)	0.08 (2)	FLAT	4	.25 (6.35)	97 oz.

Note: Dimensions in inches (millimeters).

Fiberglass Subpanels for All Premier and JIC Non-metallic Enclosures

Subpanel Part Number	Subpanel Size HxW	Enclosure Size HxW	BA	BB	BK	BL	BT	Panel Type	Number of Holes	Hole Diameter	Wt.
HW-MP604FG	4.88 x 2.88 (124 x 73)	6 x 4 (152 x 102)	4.88 (124)	2.88 (73)	4.25 (108)	2.25 (57)	0.08 (2)	FLAT	4	.25 (6.35)	2 oz.
HW-MP606FG	4.88 x 4.88 (124 x 124)	6 x 6 (152 x 152)	4.88 (124)	4.88 (124)	4.25 (108)	4.25 (108)	0.08 (2)	FLAT	4	.25 (6.35)	3 oz.
HW-MP806FG	6.88 x 4.88 (175 x 124)	8 x 6 (203 x 152)	6.75 (152)	4.88 (124)	6.25 (159)	4.25 (108)	0.08 (2)	FLAT	4	.25 (6.35)	4 oz.
HW-MP808FG	6.88 x 6.88 (175 x 175)	8 x 8 (203 x 203)	6.88 (175)	6.88 (175)	6.25 (159)	6.25 (159)	0.08 (2)	FLAT	4	.25 (6.35)	5 oz.
HW-MP1008FG	8.88 x 6.88 (225 x 175)	10 x 8 (254 x 203)	8.75 (225)	6.88 (175)	8.25 (210)	6.25 (159)	0.08 (2)	FLAT	4	.25 (6.35)	8 oz.
HW-MP1210FG	10.88 x 8.88 (276 x 225)	12 x 10 (305 x 254)	10.88 (276)	8.75 (225)	10.25 (260)	8.25 (210)	0.08 (2)	FLAT	4	.25 (6.35)	14 oz.
HW-MP1412FG	12.88 x 10.88 (327 x 276)	14 x 12 (356 x 305)	12.88 (327)	10.88 (276)	12.25 (311)	10.25 (260)	0.08 (2)	FLAT	4	.25 (6.35)	16 oz.
HW-MP1614FG	14.88 x 12.88 (378 x 327)	16 x 14 (406 x 356)	14.88 (378)	12.88 (327)	14.25 (362)	12.25 (311)	0.08 (2)	FLAT	4	.25 (6.35)	13 oz.
HW-MP1816FG	16.88 x 14.88 (429 x 378)	18 x 16 (457 x 406)	16.88 (429)	14.88 (378)	16.25 (413)	14.25 (362)	0.08 (2)	FLAT	4	.25 (6.35)	32 oz.
HW-MP2016FG	18.88 x 14.88 (479 x 378)	20 x 16 (508 x 406)	18.88 (479)	14.88 (378)	18.25 (464)	14.25 (362)	0.08 (2)	FLAT	4	.25 (6.35)	36 oz.

Note: Dimensions in inches (millimeters).

DATA SUBJECT TO CHANGE WITHOUT NOTICE

Subpanels - Non-Metallic Enclosures
Subpanels for All Premier and JIC Non-metallic Enclosures

Stainless Steel Subpanels for All Premier and JIC Non-metallic Enclosures

Subpanel Part Number	Subpanel Size HxW	Enclosure Size HxW	BA	BB	BK	BL	BT	Panel Type	Number of Holes	Hole Diameter	Wt.
HW-MP604SS	4.88 x 2.88 (124 x 73)	6 x 4 (152 x 102)	4.88 (124)	2.88 (73)	4.25 (108)	2.25 (57)	0.08 (2)	FLAT	4	.25 (6.35)	5 oz.
HW-MP606SS	4.88 x 4.88 (124 x 124)	6 x 6 (152 x 152)	4.88 (124)	4.88 (124)	4.25 (108)	4.25 (108)	0.08 (2)	FLAT	4	.25 (6.35)	8 oz.
HW-MP806SS	6.88 x 4.88 (175 x 124)	8 x 6 (203 x 152)	6.75 (152)	4.88 (124)	6.25 (159)	4.25 (108)	0.08 (2)	FLAT	4	.25 (6.35)	12 oz.
HW-MP808SS	6.88 x 6.88 (175 x 175)	8 x 8 (203 x 203)	6.88 (175)	6.88 (175)	6.25 (159)	6.25 (159)	0.08 (2)	FLAT	4	.25 (6.35)	12 oz.
HW-MP1008SS	8.88 x 6.88 (225 x 175)	10 x 8 (254 x 203)	8.75 (225)	6.88 (175)	8.25 (210)	6.25 (159)	0.08 (2)	FLAT	4	.25 (6.35)	19 oz.
HW-MP1210SS	10.88 x 8.88 (276 x 225)	12 x 10 (305 x 254)	10.88 (276)	8.75 (225)	10.25 (260)	8.25 (210)	0.08 (2)	FLAT	4	.25 (6.35)	30 oz.
HW-MP1412SS	12.88 x 10.88 (327 x 276)	14 x 12 (356 x 305)	12.88 (327)	10.88 (276)	12.25 (311)	10.25 (260)	0.08 (2)	FLAT	4	.25 (6.35)	45 oz.
HW-MP1614SS	14.88 x 12.88 (378 x 327)	16 x 14 (406 x 356)	14.88 (378)	12.88 (327)	14.25 (362)	12.25 (311)	0.08 (2)	FLAT	4	.25 (6.35)	60 oz.
HW-MP1816SS	16.88 x 14.88 (429 x 378)	18 x 16 (457 x 406)	16.88 (429)	14.88 (378)	16.25 (413)	14.25 (362)	0.08 (2)	FLAT	4	.25 (6.35)	96 oz.
HW-MP2016SS	18.88 x 14.88 (479 x 378)	20 x 16 (508 x 406)	18.88 (479)	14.88 (378)	18.25 (464)	14.25 (362)	0.08 (2)	FLAT	4	.25 (6.35)	97 oz.

Note: Dimensions in inches (millimeters).

Aluminum Subpanels for All Premier and JIC Non-metallic Enclosures

Subpanel Part Number	Subpanel Size HxW	Enclosure Size HxW	BA	BB	BK	BL	BT	Panel Type	Number of Holes	Hole Diameter	Wt.
HW-MP604A	4.88 x 2.88 (124 x 73)	6 x 4 (152 x 102)	4.88 (124)	2.88 (73)	4.25 (108)	2.25 (57)	0.08 (2)	FLAT	4	.25 (6.35)	2 oz.
HW-MP606A	4.88 x 4.88 (124 x 124)	6 x 6 (152 x 152)	4.88 (124)	4.88 (124)	4.25 (108)	4.25 (108)	0.08 (2)	FLAT	4	.25 (6.35)	3 oz.
HW-MP806A	6.88 x 4.88 (175 x 124)	8 x 6 (203 x 152)	6.75 (152)	4.88 (124)	6.25 (159)	4.25 (108)	0.08 (2)	FLAT	4	.25 (6.35)	4 oz.
HW-MP808A	6.88 x 6.88 (175 x 175)	8 x 8 (203 x 203)	6.88 (175)	6.88 (175)	6.25 (159)	6.25 (159)	0.08 (2)	FLAT	4	.25 (6.35)	4 oz.
HW-MP1008A	8.88 x 6.88 (225 x 175)	10 x 8 (254 x 203)	8.75 (225)	6.88 (175)	8.25 (210)	6.25 (159)	0.08 (2)	FLAT	4	.25 (6.35)	8 oz.
HW-MP1210A	10.88 x 8.88 (276 x 225)	12 x 10 (305 x 254)	10.88 (276)	8.75 (225)	10.25 (260)	8.25 (210)	0.08 (2)	FLAT	4	.25 (6.35)	12 oz.
HW-MP1412A	12.88 x 10.88 (327 x 276)	14 x 12 (356 x 305)	12.88 (327)	10.88 (276)	12.25 (311)	10.25 (260)	0.08 (2)	FLAT	4	.25 (6.35)	18 oz.
HW-MP1614A	14.88 x 12.88 (378 x 327)	16 x 14 (406 x 356)	14.88 (378)	12.88 (327)	14.25 (362)	12.25 (311)	0.08 (2)	FLAT	4	.25 (6.35)	24 oz.
HW-MP1816A	16.88 x 14.88 (429 x 378)	18 x 16 (457 x 406)	16.88 (429)	14.88 (378)	16.25 (413)	14.25 (362)	0.08 (2)	FLAT	4	.25 (6.35)	40 oz.
HW-MP2016A	18.88 x 14.88 (479 x 378)	20 x 16 (508 x 406)	18.88 (479)	14.88 (378)	18.25 (464)	14.25 (362)	0.08 (2)	FLAT	4	.25 (6.35)	39 oz.

Note: Dimensions in inches (millimeters).

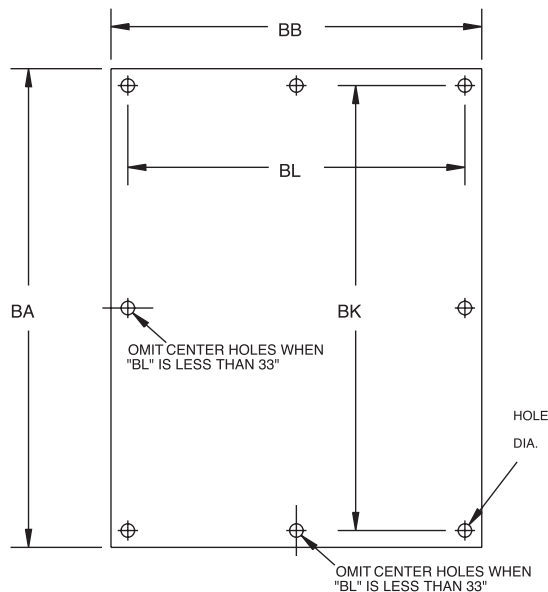

DATA SUBJECT TO CHANGE WITHOUT NOTICE

Control Series Subpanels Non-Metallic Enclosures Subpanels for Control Series Non-metallic Enclosures

Carbon Steel Subpanels for Control Series Non-metallic Enclosures

Subpanel Part Number	Subpanel Size HxW	Enclosure Size HxW	BA	BB	BK	BL	BT	Panel Type	Number of Holes	Hole Diameter	Wt.
HW-WM1610CS	13.00 x 8.50 (330 x 216)	16 x 10 (406 x 54)	13.00 (330)	8.50 (216)	12.00 (305)	7.50 (191)	0.08 (2)	Flat	4	0.31 (8)	3.3 lbs.
HW-WM2016CS	17.00 x 13.00 (432 x 330)	20 x 16 (508 x 406)	17.00 (432)	13.00 (330)	15.25 (387)	11.25 (286)	0.09 (2)	Formed	4	0.31 (8)	6.7 lbs.
HW-WM2412CS	21.00 x 9.00 (533 x 229)	24 x 12 (610 x 305)	21.00 (533)	9.00 (229)	19.25 (489)	7.25 (184)	0.09 (2)	Formed	4	0.50 (13)	8.7 lbs.
HW-WM2420CS	21.00 x 17.00 (533 x 432)	24 x 20 (610 x 508)	21.00 (533)	17.00 (432)	19.25 (489)	15.25 (387)	0.13 (3)	Formed	4	0.50 (13)	10.8 lbs.
HW-WM2424CS	21.00 x 21.00 (533 x 533)	24 x 24 (610 x 610)	21.00 (533)	21.00 (533)	19.25 (489)	19.25 (489)	0.13 (3)	Formed	4	0.50 (13)	13.4 lbs.
HW-WM3020CS	27.00 x 17.00 (686 x 432)	30 x 20 (763 x 508)	27.00 (686)	17.00 (432)	25.25 (641)	15.25 (387)	0.13 (3)	Formed	5	0.50 (13)	14 lbs.
HW-WM3024CS	27.00 x 21.00 (686 x 533)	30 x 24 (762 x 610)	27.00 (686)	21.00 (533)	25.25 (641)	19.25 (489)	0.13 (3)	Flat	4	0.50 (13)	17 lbs.
HW-WM3630CS	33.00 x 27.00 (838 x 686)	36 x 30 (914 x 762)	33.00 (838)	27.00 (686)	31.25 (794)	25.25 (641)	0.13 (3)	Flat	4	0.50 (13)	27 lbs.
HW-WM4836CS	31.00 x 22.00 (787 x 559)	36 x 48 (914 x 1219)	31.00 (787)	22.00 (559)	29.00 (737)	20.00 (508)	0.13 (3)	Flat	8	0.50 (13)	41 lbs.
HW-WM6036CS	57.00 x 33.00 (1448 x 838)	60 x 36 (1524 x 914)	57.00 (1448)	33.00 (838)	55.25 (1403)	31.25 (794)	0.13 (3)	Formed	8	0.50 (13)	60 lbs.

Note: Dimensions in inches (millimeters).

Aluminum Subpanels for Control Series Non-metallic Enclosures

Subpanel Part Number	Subpanel Size HxW	Enclosure Size HxW	BA	BB	BK	BL	BT	Panel Type	Number of Holes	Hole Diameter	Wt.
HW-WM1610A	13.00 x 8.50 (330 x 216)	16 x 10 (406 x 54)	13.00 (330)	8.50 (216)	12.00 (305)	7.50 (191)	0.08 (2)	Flat	4	0.31 (8)	1 lb.
HW-WM2016A	17.00 x 13.00 (432 x 330)	20 x 16 (508 x 406)	17.00 (432)	13.00 (330)	15.25 (387)	11.25 (286)	0.09 (2)	Formed	4	0.31 (8)	2 lbs.
HW-WM2412A	21.00 x 9.00 (533 x 229)	24 x 12 (610 x 305)	21.00 (533)	9.00 (229)	19.25 (489)	7.25 (184)	0.09 (2)	Formed	4	0.50 (13)	4.5 lbs.
HW-WM2420A	21.00 x 17.00 (533 x 432)	24 x 20 (610 x 508)	21.00 (533)	17.00 (432)	19.25 (489)	15.25 (387)	0.13 (3)	Formed	4	0.50 (13)	4.5 lbs.
HW-WM2424A	21.00 x 21.00 (533 x 533)	24 x 24 (610 x 610)	21.00 (533)	21.00 (533)	19.25 (489)	19.25 (489)	0.13 (3)	Formed	4	0.50 (13)	5.5 lbs.
HW-WM3020A	27.00 x 17.00 (686 x 432)	30 x 20 (763 x 508)	27.00 (686)	17.00 (432)	25.25 (641)	15.25 (387)	0.13 (3)	Formed	5	0.50 (13)	5.8 lbs.
HW-WM3024A	27.00 x 21.00 (686 x 533)	30 x 24 (762 x 610)	27.00 (686)	21.00 (533)	25.25 (641)	19.25 (489)	0.13 (3)	Flat	4	0.50 (13)	7 lbs.
HW-WM3630A	33.00 x 27.00 (838 x 686)	36 x 30 (914 x 762)	33.00 (838)	27.00 (686)	31.25 (794)	25.25 (641)	0.13 (3)	Flat	4	0.50 (13)	11 lbs.
HW-WM4836A	31.00 x 22.00 (787 x 559)	36 x 48 (914 x 1219)	31.00 (787)	22.00 (559)	29.00 (737)	20.00 (508)	0.13 (3)	Flat	8	0.50 (13)	22 lbs.
HW-WM6036A	57.00 x 33.00 (1448 x 838)	60 x 36 (1524 x 914)	57.00 (1448)	33.00 (838)	55.25 (1403)	31.25 (794)	0.13 (3)	Formed	8	0.50 (13)	23 lbs.

Note: Dimensions in inches (millimeters).

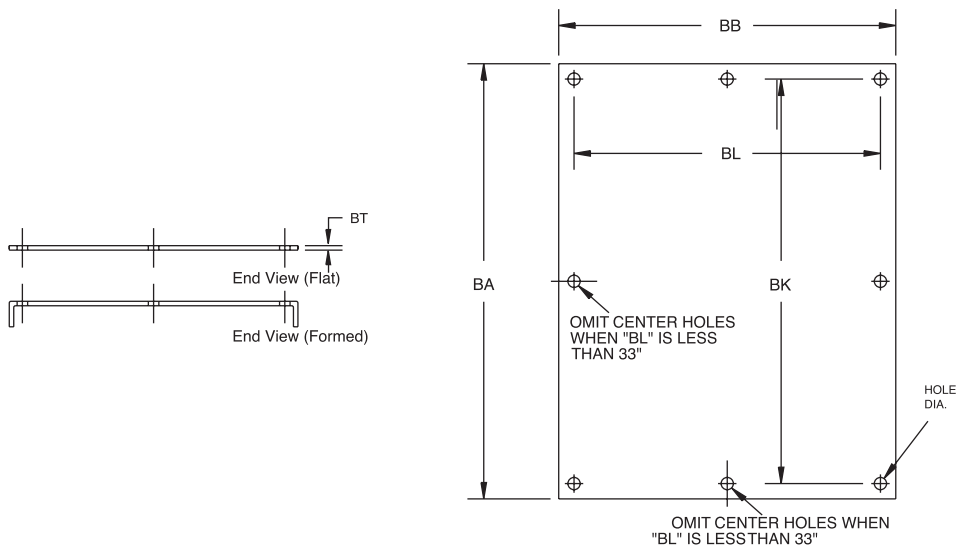

Note: Subpanels less than 33" wide do not have center holes as shown.

DATA SUBJECT TO CHANGE WITHOUT NOTICE

**Non-Metallic Enclosures
Accessories**

**Optional Mounting
Foot Kits**

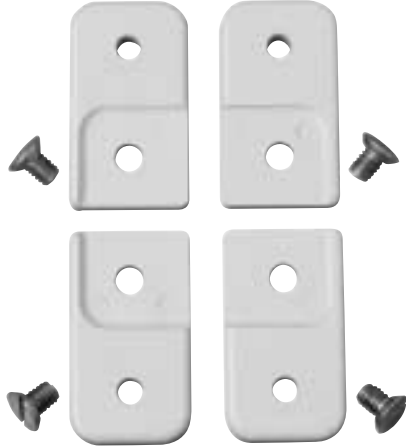

Part Number	Description	Wt.
HW-MGFTKIT	Mounting Foot Kit for Premier Series (4 pieces per kit)	1 oz.
HW-N4XMGFTKIT	Mounting Foot Kit for Slim Line & In-Line Series (4 pieces per kit)	1 oz.

Hole Plugs



Part Number	Description	Wt.
HW-FGHP	Non-metallic hole plug, for .5 to .75 inch diameter hole	2 oz.
HW-FGHP-PB-075	Non-metallic hole plug for .75 to 1.00 inch diameter hole	2 oz.
HW-FGHP-100-125	Non-metallic hole plug for 1.00 to 1.25 inch diameter hole	2 oz.
HW-FGHP-150-200	Non-metallic hole plug for 1.50 to 2.00 inch diameter hole	2 oz.

Drain Vent



Part Number	Description	Wt.
HW-DV	Single Drain Vent	2 oz.
HW-DVKIT	Single Drain Vent, epoxy screws	2 oz.

DATA SUBJECT TO CHANGE WITHOUT NOTICE

Non-Metallic Enclosures Accessories

Stainless Steel Screws

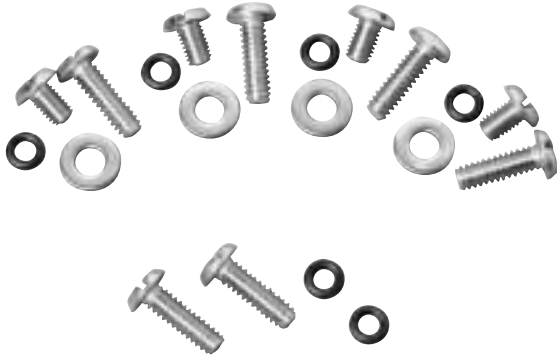

Part Number	Description	Wt.
HW-2PKSS	Stainless steel screws - pkg of 2	1 oz.
HW-4PKSS	Stainless steel screws - pkg of 4	1 oz.

Vapor Capsule



Part Number	Description	Wt.
HW-C12	Non-toxic vapor capsule prevents moisture and condensation from occurring on the interior of the enclosure for up to one year. Installs easily with a self-adhesive strip.	1 oz.

Encapsulated Screws



Part Number	Description	Wt.
HW-2PKENCAP	PVC-encapsulated screws - pkg of 2	1 oz.
HW-4PKENCAP	PVC-encapsulated screws - pkg of 4	1 oz.

Louver Plate and Kit

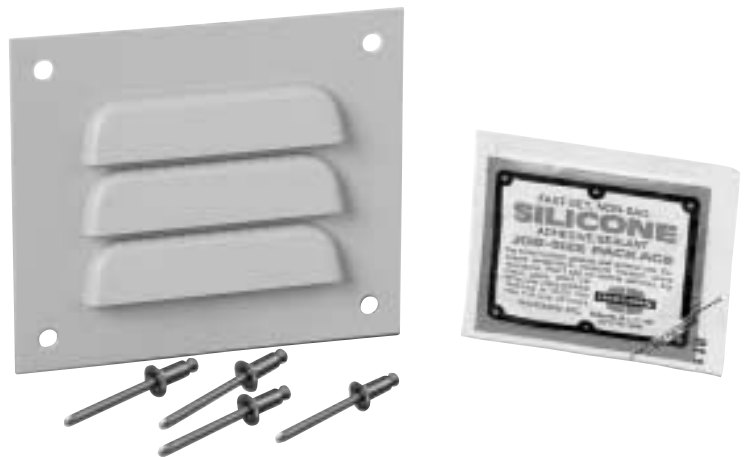

Part Number	Description	Wt.
HW-LP	Louver plate only	2 oz.
HW-LPKIT	Louver plate, rivets, silicone	2 oz.

Carrying Handle



Part Number	Description	Wt.
HW-CarryingHandle	Non-metallic black handle	2 oz.

DATA SUBJECT TO CHANGE WITHOUT NOTICE